

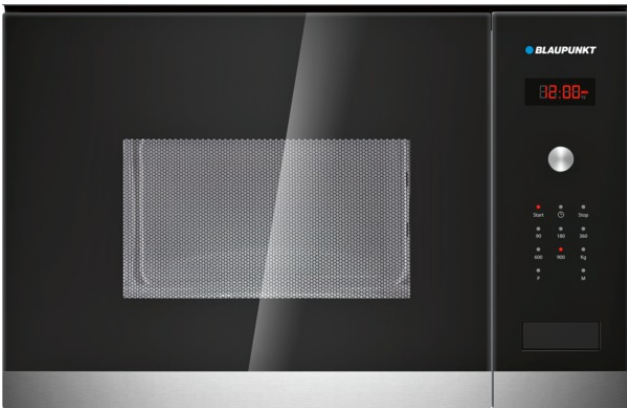

5MA36700 brushed steel
Microwave oven



5MA36700 Stainless steel

- Tall housing, Can be built in a 60 cm wall cupboard (at least 30cm deep)
- Simple operating electronics mit und Rotary Control, Retractable controls
- 900 W Microwave
- 5 settings: 900 W, 600W, 360W, 180W, 90W
- cookControl - 7 automatic programmes
- 4 defrost programs
- 3 cooking programs
- Memory-Function (1 setting)
- Time-of-day display
- Glass oven door Side-hinge door
- 25 l Stainless steel
- Interior lighting
- 31.5 cm Glass
- Out put power 1.45 kW
- Power cord with plug 130 cm

4251003100341

5MA36700 brushed steel Microwave oven

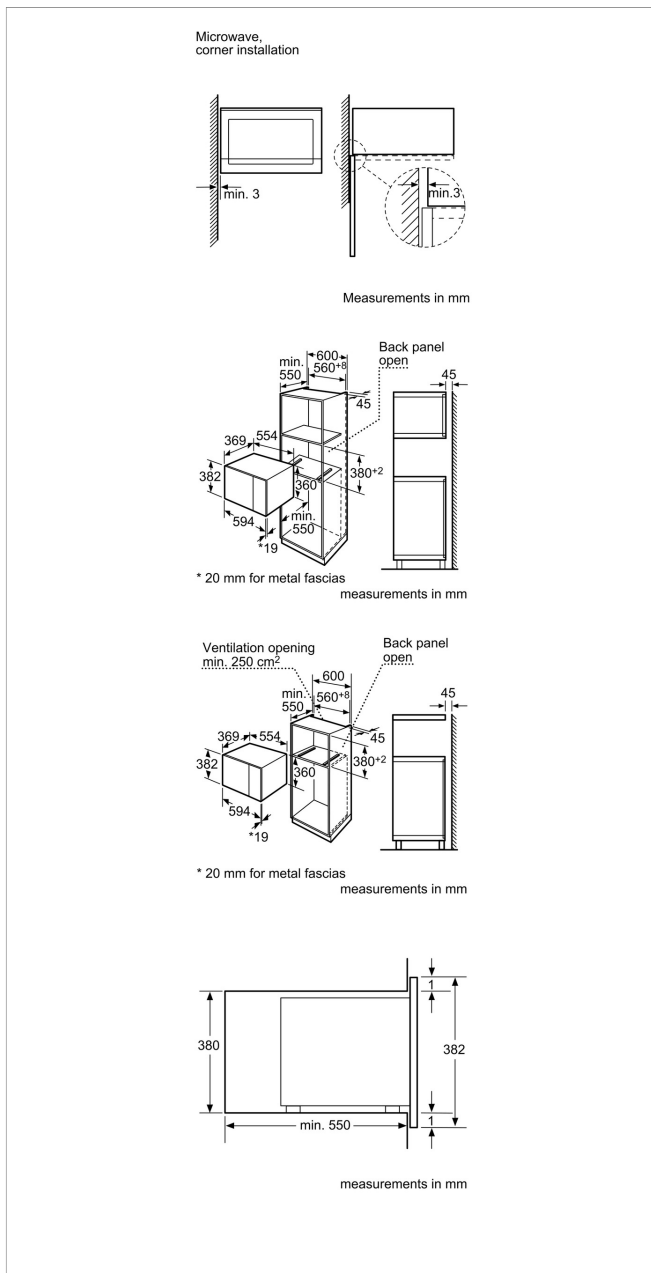

Characteristics

Type of micro-wave oven: MW only
 Type of control: Electronic
 Color / Material Front: Stainless steel
 Dimensions of the product (mm): 382 x 594 x 388
 Cavity dimensions (mm): 208.0 x 328.0 x 369.0
 Length electrical supply cord (cm): 130
 Net weight (kg): 18.0
 Gross weight (kg): 20.0
 Maximum micro-wave power (W): 900
 Number of Power Levels: 5
 Turntable: Yes
 Heating type: Microwave
 Cavity material: Stainless steel
 Door opening: Button
 Clock: Yes
 Main colour of product: Stainless steel
 Height of the product (mm): 382
 Width of the product (mm): 594
 Depth of the product: 388

Consumption and connection features

Maximum micro-wave power (W): 900
 Power of the booster function (W):
 Connection Rating (W): 1450
 Current (A): 10
 Voltage (V): 220-230
 Frequency (Hz): 50
 Plug type: GARDY plug w/ earthing
 Universal Product Code:
 Color / Material Front: Stainless steel
 Alternative colors available:
 Approval certificates: CE
 Length of electrical supply cord (in):
 Required cutout/niche size for installation (in): x x
 Appliance Dimensions (h x w x d) (in): x x
 Dimensions of the packed product (in): 17.32 x 14.17 x 25.19
 Net weight (lbs): 40
 Gross weight (lbs): 44

2016-09-02